

MODERN CLASSIC

Made to Measure

The best thing to do is to take the floor plan of your living room and then to plan your very own made-to-measure suite – even the planning stage can be fun.

You can decide whether you want a classic suite or a luxurious upholstered seating group. Choose the armrest you like best, decide what level of upholstered comfort you want. To ensure your plans don't remain on the drawing board, pay a visit to your dealer to see »Modern & Classic made to measure« for yourself.

Take a seat and discover the comfort we can offer at first hand.



Modern & Classic Made to Measure

Armrest design - a question of taste

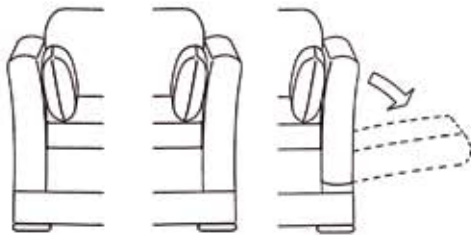

612 Bardelli
Armrest
B/W 18 cm
H 72 cm

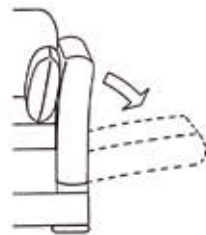

612 Bardelli
Folding armrest
B/W 18/53 cm
H 72 cm

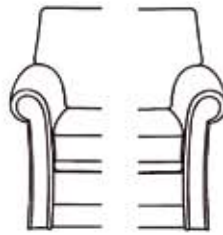

614 Bali
Armrest
B/W 21 cm
H 64 cm

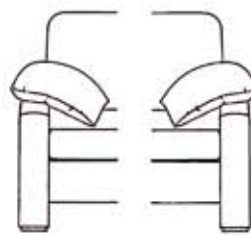

616 Barcetta
Low armrest with
cushion
B/W 14 cm
H 56 cm

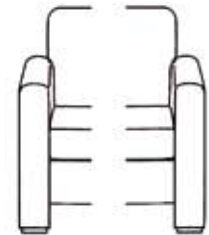

616 Barcetta
High armrest
B/W 14 cm
H 62 cm

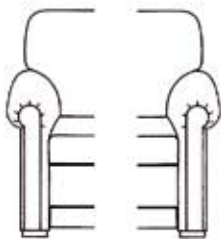

619 Bardelli
Armrest
B/W 19 cm
H 63 cm

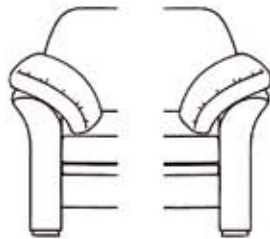

620 Batavia
Armrest with
cushion, B/W 24
cm, H 59 cm

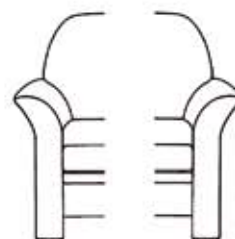

620 Batavia
Armrest
B/W 18 cm
H 64 cm

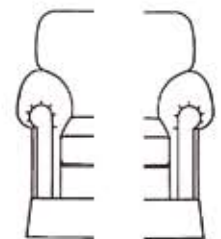

622 Bahia
Armrest
B/W 18 cm
H 63 cm

Seat comfort: firm, medium, semi-soft, soft

Choose the level of comfort you want:

for the seat: Firm = Cold formed foam fixed upholstery
Medium = Loose Lastilux cushions
Semi-soft = Loose pocket feather core cushions
Soft = Loose Rhombolux cushions

for the back: Loose Rhombolux cushions



Armchair
Seat width 53 cm
+ armrests



2-seater sofa
Seat width 116, 126, 136,
146, 156, 176, 196 cm
+ armrests

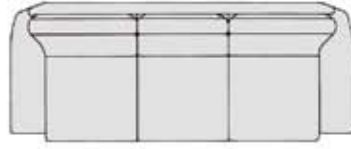

3-seater-sofa
Seat width 159, 164, 169, 174,
179, 184 oder 189 cm
+ armrests



Bed-sofa, 2-seater
Seat width 136 cm
= Bed-area 116x190 cm
Seat width 156 cm
= Bed-area 136x190 cm
+ armrests

The Extendible Seating Group Range

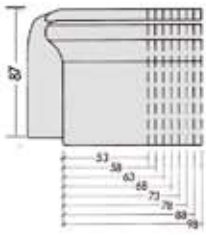

Seating element
Armrest left
B/W 53, 58, 63, 68,
73, 78, 88, 98 cm
+ armrest

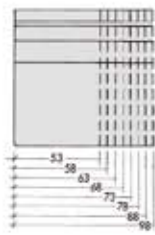

Seating element
no Armrest
B/W 53, 58, 63, 68,
73, 78, 88, 98 cm

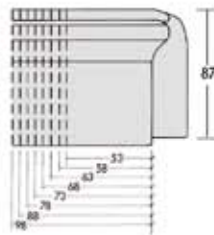

Seating element
Armrest right
B/W 53, 58, 63, 68,
73, 78, 88, 98 cm
+ armrest



Ottoman
Armrest left
B/W 63,
T/D 170 cm
+ armrest

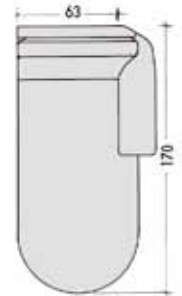

Ottoman
Armrest right
B/W 63,
T/D 170 cm
+ armrest

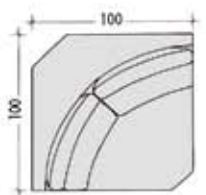

Rounded corner
element
B/W 100,
T/D 100 cm

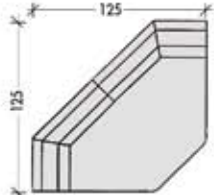

Angled corner
element
B/W 125,
T/D 125 cm

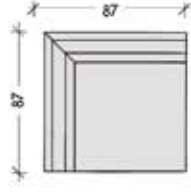

Point corner
element
B/W 87,
T/D 87 cm

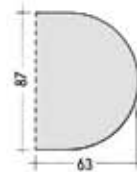

Round finial,
right, B/W 63,
T/D 87 cm
Only for joining
to seat width

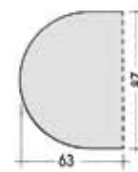

Round finial, left
B/W 63,
T/D 87 cm
Only for joining
to seat width



Stool
B/W 72,
T/D 56 cm

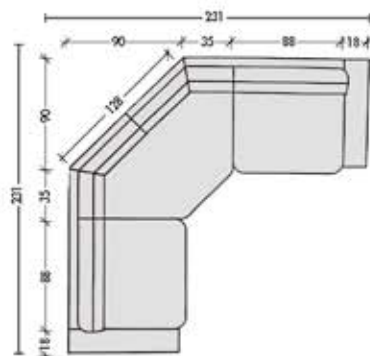

Sample plan

Corner with armrest 612 Bardelli

Armrest 612 Bardelli	18 cm
Seating element	88 cm
Angled corner element	125x125 cm
Seating element	88 cm
Armrest 612 Bardelli	18 cm

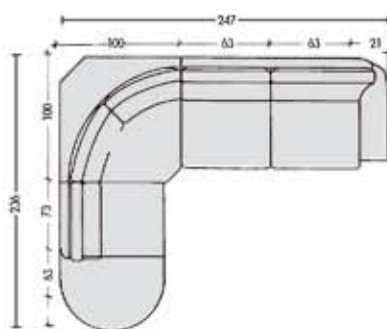

Sample plan

Corner with armrest 614 Bali

Round finial	63 cm
Seating element	73 cm
Rounded corner element	100x100 cm
Seating element	63 cm
Seating element	63 cm
Seating element	63 cm
Armrest 614 Bali	21 cm

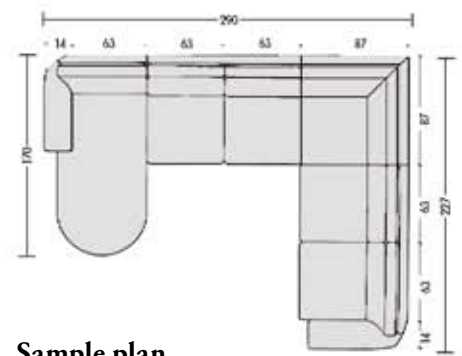

Sample plan

Corner with armrest 616 Barcetta

Armrest 616 Barcetta	14 cm
Ottoman, armrest left	63 cm
Seating element	63 cm
Seating element	63 cm
Point corner element	87x87 cm
Seating element	63 cm
Seating element	63 cm
Armrest 616 Barcetta	14 cm